

# PM01.EX

INTRINSICALLY SAFE POWER SUPPLY

## USER MANUAL











ITKU-99-01-07-17-EN



**RADWAG**  
RADWAG BALANCES AND SCALES  
ADVANCED WEIGHING TECHNOLOGIES

## PRECAUTIONS

Prior installation, use or maintenance activities, carefully read this User Manual. Use the PM01.EX-\* power supply only as intended. This user manual must be at a reach of the operator's hand in the course of device operation.

	Symbol marking sections that are extremely important for protection against explosion.
	The device must be applied in accordance with the intended use only.
	Prior installation and start, it is necessary to analyse whether the device complies with the usage requirements regarding particular hazardous area.
	In case of any sign of damage, it is necessary to disconnect the device from the mains immediately. The damaged component must be replaced or repaired by RADWAG service immediately.
	While installing the device, it is necessary to follow strictly this user manual requirements. Not adhering to the requirements results with loss of explosion safety.
	The PM01.EX-* power supply can be connected only to intrinsically safe instruments characterised with respective intrinsic safety parameters provided further down this user manual. Connection method must be accordant with this user manual requirements. Connecting other than intrinsically safe or certified device, results with loss of explosion safety of the complete set.
	The PM01.EX-* power supply may be used as a component of device/set intended for operation in hazardous area. Manufacturer of such device/set is obliged to carry out analysis of the complete device/set in order to confirm compliance with standards.
	The device must be connected to the grounding permanently.
	To minimize the risk of electrostatic discharges, it is not allowed to use the device in places, where mechanisms causing electrostatic charges greater than those caused by rubbing the surface by hand, occur.
	Technical condition of the power supply must be tested and inspected by a trained personnel, in accordance with this user manual, at least once every three months.

# CONTENTS

<b>1. INTENDED USE AND DESIGN</b> .....	<b>4</b>
<b>2. TECHNICAL SPECIFICATIONS</b> .....	<b>7</b>
<b>3. USAGE CONDITIONS</b> .....	<b>7</b>
3.1. Electrostatic Charges Hazard.....	7
3.2. PM01.EX-1 and PM01.EX-2 Power Supply Output Parameters .....	7
3.3. Device with Permanently Fixed Wires .....	8
<b>4. WARRANTY CONDITIONS</b> .....	<b>8</b>
<b>5. SAFETY REQUIREMENTS</b> .....	<b>9</b>
5.1. ATEX Markings – Symbols Meaning .....	10
5.2. Data Plates.....	11
5.3. Information Stickers Arrangement .....	12
<b>6. INSTALLATION AND START-UP</b> .....	<b>13</b>
6.1. Power Supply Arrangement.....	13
6.2. Connectors Arrangement .....	13
6.3. Power Supply Grounding.....	14
6.4. Connecting PUE HX5.EX-* Indicator to the Power Supply .....	14
6.5. Connecting PM01.EX-* to the Mains .....	16
<b>7. MAINTENANCE ACTIVITIES</b> .....	<b>17</b>
<b>8. TECHNICAL CONDITION INSPECTION</b> .....	<b>17</b>
<b>9. SERVICE AND REPAIR</b> .....	<b>18</b>
<b>10. UTILISATION</b> .....	<b>18</b>
<b>11. STANDARDS LIST</b> .....	<b>19</b>

# 1. INTENDED USE AND DESIGN

The PM01.EX-\* power supply is equipped with intrinsically safe output circuits and is powered from the mains of the following voltage: 100÷240V AC. The power supply is an associated device intended to be permanently fixed by cable at the workstation. The power supply is intended for supplying intrinsically safe instruments, including PUE HX5.EX-\* indicator.

**The power supply consists of the following components:**

1	Stainless steel housing cover.
2	Stainless steel housing base.
3	Fastening bolts.
4	Power supply electronics covered with filling compound.
5	Intrinsically safe circuit connector.
6	Receiver power cord.
7	Power cord.
8	Cable glands.
9	Grounding terminal

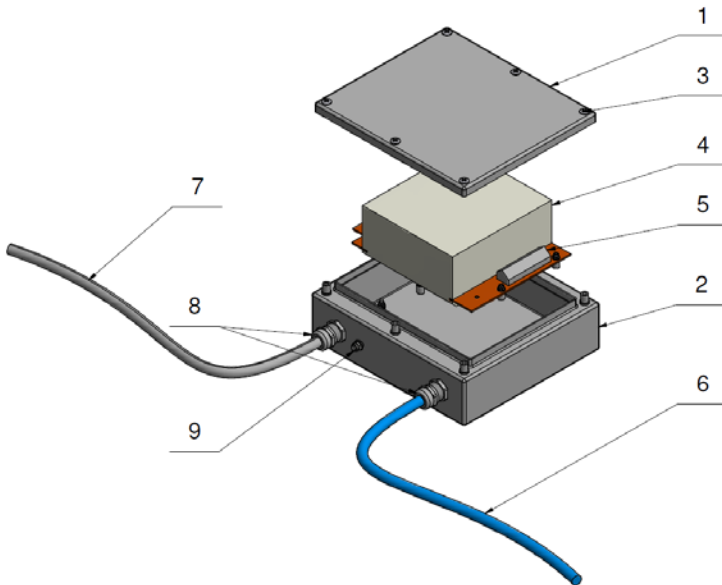

*Fig. 1. Main components of the power supply*

**PM01.EX-\* power supply comes in two installation options:**

Installation option - 1: power supply intended for operation in hazardous area.

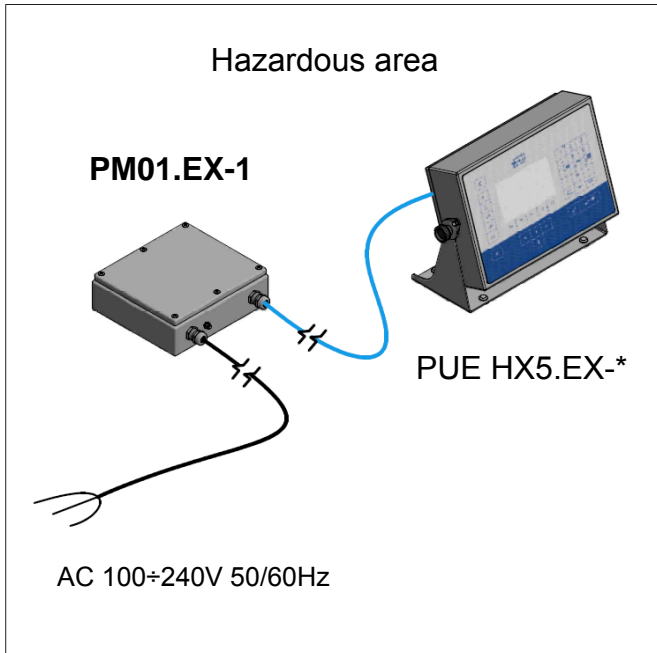

*Fig.2. Power supply in hazardous area*

Installation option - 2: power supply intended for operation in safe area, equipped with intrinsically safe circuits which may be placed in hazardous area.

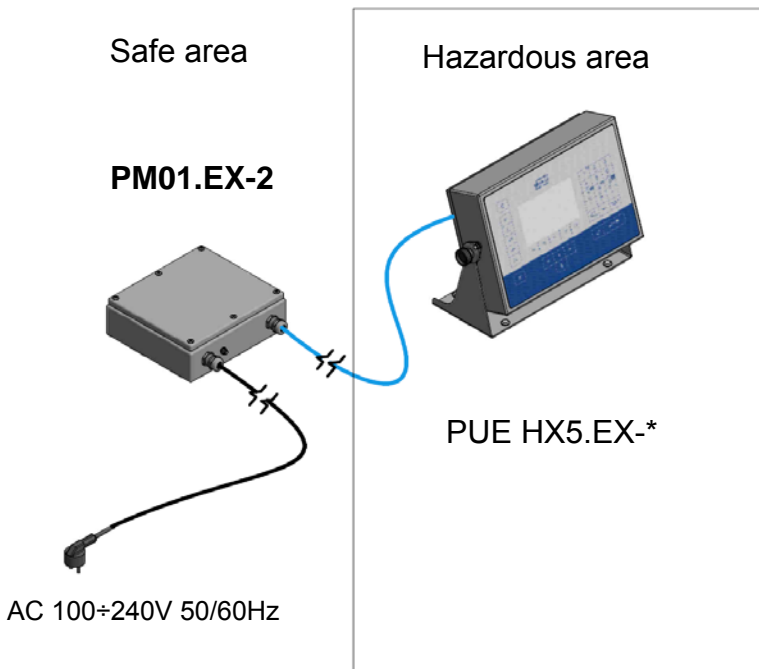



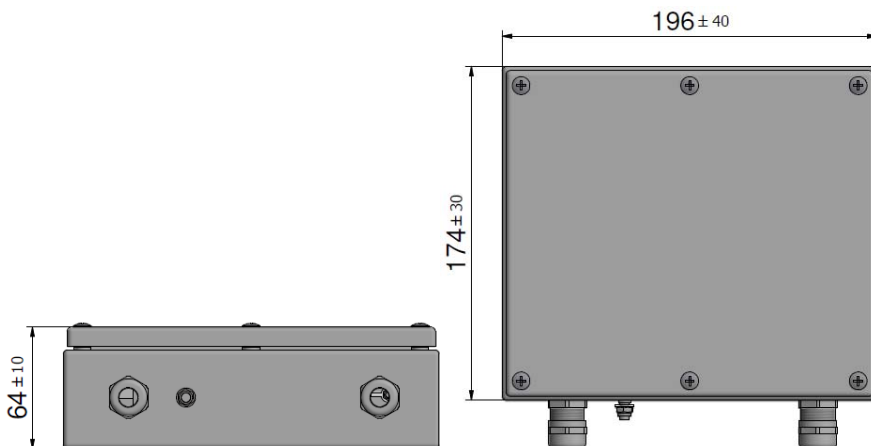

*Fig .3. Power supply in safe area*

**PM01.EX-\* power supply – dimensions:**



*Fig.4. External view– dimensions*

## 2. TECHNICAL SPECIFICATIONS

	PM01.EX-1	PM01.EX-2
Housing	Stainless steel	Stainless steel
IP ingress protection by EN 60529	IP66/IP68	IP66/IP68
Power supply	100÷240VAC 50/60Hz	100÷240VAC 50/60Hz
Ambient temperature	-20°C ÷ 40°C	-20°C ÷ 40°C
Relative humidity	10÷85% RH non-condensing conditions	10÷85% RH non-condensing conditions
Certificate	KDB 17ATEX0063X	KDB 17ATEX0063X
Marking for gases	 II 2G Ex eb mb [ib] IIC T4 Gb	 II (2)G [Ex ib Gb] IIC
Marking for dusts	 II 2D Ex tb [ib] IIIC T60°C Db	 II (2)D [Ex ib Db] IIIC
Operation in hazardous area	(gases) 1, 2 (dusts) 21, 22	(gases) 1, 2 (dusts) 21, 22

## 3. USAGE CONDITIONS

### 3.1. Electrostatic Charges Hazard

In order to minimize electrostatic charges hazard it is necessary to:

- make sure that the power supply is permanently grounded in the course of operation,
- follow cleaning-relevant recommendations that are to be found in section 7 of this user manual.

	<b><i>It is not allowed to use the power supply in places, where mechanisms causing electrostatic charges greater than those caused by rubbing the surface by hand, occur.</i></b>
--	--

### 3.2. PM01.EX-1 and PM01.EX-2 Power Supply Output Parameters

Circuit mark	U <sub>o</sub>	I <sub>o</sub>	P <sub>o</sub>	Condensed values		Distributed values (cable)	
				C <sub>o</sub>	L <sub>o</sub>	C <sub>o</sub>	L <sub>o</sub>
V1	7.60V	600mA	3.8W	1µF	89µH	10µF	89µH
V2	7.14V	118mA	0.7W	2.1µF	200µH	13µF	300 µH
V3	8.60V	87mA	0.64W	0.71µF	1mH	6.2µF	3.1mH
V4	13.65V	42mA	0.52W	0.49µF	0.5mH	0.7µF	6.4mH

### **3.3. Device with Permanently Fixed Wires**

During installation it is allowed to disconnect the power cord from the receiver. Disconnecting and reconnecting procedures of the power cord has to be carried out in accordance with good engineering practice. For detailed information concerning the procedures read section 6.4 of this user manual.

## **4. WARRANTY CONDITIONS**

- A. RADWAG feels obliged to repair or exchange all elements that appear to be faulty by production or by construction.
- B. Defining defects of unclear origin and means of their elimination can only be realized with assistance of manufacturer and user representatives.
- C. RADWAG does not bear any responsibility for damage or losses resulting from incorrect, or unauthorized manufacturing processes or servicing.
- D. The warranty does not cover:
  - mechanical damage caused by product exploitation other than intended, damage of thermal and chemical origin, damage caused by lightning, overvoltage in the power network or other random event,
  - inappropriate cleaning habits.
- E. Loss of warranty takes place if:
  - a repair is carried out outside RADWAG authorized service point,
  - service claims intrusion into mechanical or electronic construction by unauthorized people,
  - the device does not have data plates or they are damaged.
- F. For detailed warranty conditions read the warranty certificate.
- G. Contact with the central authorized service: +48 48 384 88 00 ext. 106 and 107.



## 5. SAFETY REQUIREMENTS

Prior the first use, carefully read this User Manual. Use the weighing device only as intended. Depending on the model, the PM01.EX-\* power supply can be used in:

- **PM01.EX-1** power supply is intended for operation in hazardous area:
  - zone 1 and 2 where there is a risk of explosion due to mixture of air with vapour, mist or gas, classified as explosion group IIC, IIB and IIA and as temperature class T1, T2, T3, T4.
  - zone 21 and 22 where there is a risk of explosion due to mixture of air with dust, flammable fibres and volatile fuels, classified as explosion group IIIC, IIIB and IIIA.

The power supply features the following marking:

for gases:  II 2G Ex eb mb [ib] IIC T4 Gb and

for dusts:  II 2D Ex tb [ib] IIIC T60°C Db.

- **PM01.EX-2** power supply is intended for operation outside hazardous area (in safe area), equipped with intrinsically safe circuits which may be placed in:

- zone 1 and 2 where there is a risk of explosion due to mixture of air with vapour, mist or gas, classified as explosion group IIC, IIB and IIA and as temperature class T1, T2, T3, T4.
- zone 21 and 22 where there is a risk of explosion due to mixture of air with dust, flammable fibres and volatile fuels, classified as explosion group IIIC, IIIB and IIIA.

The power supply features the following marking:

for gases:  II (2)G [Ex ib Gb] IIC and

for dusts:  II (2)D [Ex ib Db] IIIC.

### Explosion safety of PM01.EX-\* power supply is ensured by:

- PM01.EX power supply is compliant with the following regulations: EN 60079-0, EN 60079-7, EN 60079-11, EN 60079-18 and EN 60079-31 confirmed by KDB 17ATEX0063X certificate.
- Not exposing the power supply to static electricity. Functional grounding cable which levels the potentials must always be connected to the marked terminal. Disconnecting the functional grounding cable is forbidden. Disconnecting potentials equalizing cable (e.g. when there is a need to place the device elsewhere) is allowed only if there is no risk of explosive atmosphere.
- **Adhering to this user manual guidelines.**

## 5.1. ATEX Markings – Symbols Meaning



II 2 G Ex ib IIC T4 Gb

Equipment group:  
 I - to be used in mines where there's risk of mine gas explosion  
 II - to be used in places where there's risk of explosion of gases other than mine gases

Types of group II devices:  
 1 - equipment providing very high protection level, - for operation in zone 0,1,2  
 2 - equipment providing high protection level, - for operation in zone 1,2  
 3 - equipment providing standard protection level, - for operation in zone 2

Explosive atmosphere:  
 G - caused by mixture of air with vapour, mist or gas  
 D - caused by mixture of air with dust

Electrical equipment corresponding with one or several anti-explosion mechanical designs

Symbol of used explosion proof mechanical design, e.g.:  
 mb - hermetic, for operation in zone 1,2,  
 tb - protection via housing for operation in zones 1,2,  
 e - increased safety  
 ia - intrinsically safe design for operation in zone 0, 1, 2,  
 ib - intrinsically safe design for operation in zone 1, 2.

Gas explosion group, examples:  
 - IIA: propane (T1) benzene (T3) butane (T2) ethanol (T2)  
 - IIB: ethylene (T2)  
 - IIC: acetylene (T2) hydrogen (T1)  
 or dust, examples:  
 - IIIA: volatile fuels  
 - IIIB: non-conductive dust  
 - IIIC: conductive dust

Max surface temperature:  
 - for gases it is specified as temperature class determining max surface temperature of device components that are in touch with explosive mixture:  
 T1: 450°C  
 T2: 300°C  
 T3: 200°C  
 T4: 135°C  
 T5: 100°C  
 T6: 85°C  
 - for dusts it is specified as max measured surface temp, e.g.:  
 T60°C

Protection class gas atmosphere:  
 - Ga  
 - Gb  
 - Gc  
 dust atmosphere:  
 - Da  
 - Db  
 - Dc

## 5.2. Data Plates

Data plates of PM01.EX-1 power supply:

1 → **RADWAG**  
www.radwag.com

2 → Model: **PM01.EX-1**

3 → S/N: **123456**

4 → KDB 17ATEX0063X

5 → 100÷240VAC 50/60Hz

6 → Ta: -20°C÷40°C

7 → **CE** 1453 IP66/IP68

**RADWAG Wagi Elektroniczne**  
Bracka 28, 26-600 Radom, Poland  
Made in Poland (EU)

II 2G Ex eb mb [ib] IIC T4 Gb  
II 2D Ex tb [ib] IIIC T60°C Db

	Uo	Io	Po	Co	Lo
V1	7,60V	600mA	3,8W	10µF	89µH
V2	7,14V	118mA	0,7W	13µF	300µH
V3	8,60V	87mA	0,64W	6,2µF	3,1mH
V4	13,65V	42mA	0,52W	0,7µF	6,4mH

PL UWAGA – ZAGROŻENIE ŁADUNKAMI ELEKTROSTATYCZNYMI - PATRZ INSTRUKCJE  
EN WARNING – POTENTIAL ELECTROSTATIC CHARGING HAZARD – SEE INSTRUCTIONS  
DE VORSICHT – GEFAHR IN ELEKTROSTATISCHEN LADUNGEN – SIEHE ANLEITUNGEN

PL UWAGA – NIE OTWIERAĆ POD NAPIĘCIEM  
EN WARNING – DO NOT OPEN WHEN ENERGIZED  
DE WARNUNG – NICHT UNTER SPANNUNG ÖFFNEN

Data plates of PM01.EX-2: power supply:

1 → **RADWAG**  
www.radwag.com

2 → Model: **PM01.EX-2**

3 → S/N: **123456**

4 → KDB 17ATEX0063X

5 → 100÷240VAC 50/60Hz

6 → Ta: -20°C÷40°C

7 → **CE** 1453 IP66/IP68

**RADWAG Wagi Elektroniczne**  
Bracka 28, 26-600 Radom, Poland  
Made in Poland (EU)

II (2)G [Ex ib Gb] IIC  
II (2)D [Ex ib Db] IIIC

	Uo	Io	Po	Co	Lo
V1	7,60V	600mA	3,8W	10µF	89µH
V2	7,14V	118mA	0,7W	13µF	300µH
V3	8,60V	87mA	0,64W	6,2µF	3,1mH
V4	13,65V	42mA	0,52W	0,7µF	6,4mH

PL UWAGA – NIE OTWIERAĆ POD NAPIĘCIEM  
EN WARNING – DO NOT OPEN WHEN ENERGIZED  
DE WARNUNG – NICHT UNTER SPANNUNG ÖFFNEN

1	Manufacturer's logo.
2	Power supply model.
3	Serial no.
4	Number of ATEX certificate issued for the power supply with „X” symbol - special conditions of use.
5	Power supply.
6	Ambient temperature.
7	CE marking + notified body no. (ATEX directive).
8	IP ingress protection
9	Manufacturer's name and address.
10	WEEE symbol.
11	EX mark: gases (read section 5.1).
12	EX mark: dusts (read section 5.1).
13	Electrical parameters.
14	Warning against danger with regard to electrostatic charges (not used for PM01.EX-2 power supply) and warning against danger with regard to opening when energized, written in Polish, English, German, other.

### 5.3. Information Stickers Arrangement

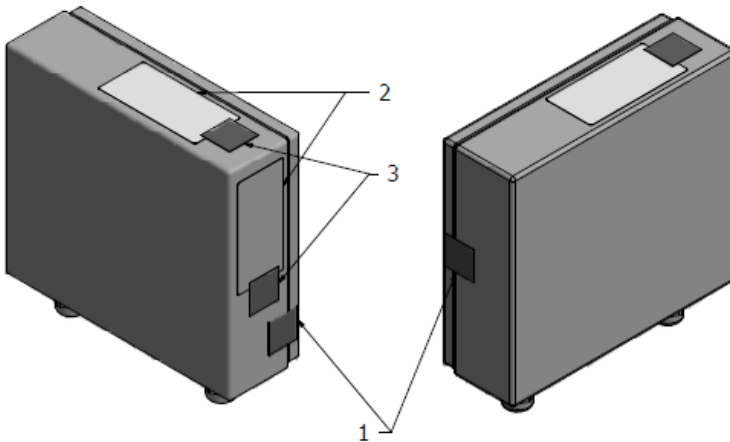



*Fig.5. Arrangement of data plates and security stickers*

- 1 - Cover's security seals
- 2 - Data plates
- 3 - Data plates' security seals (in case of data plates of void seal type, the security seals are not used)

## 6. INSTALLATION AND START-UP

Prior installation and start-up, carefully read this User Manual. Use the device only as intended.

RADWAG does not bear any responsibility for damage or losses resulting either from improperly carried out installation or misuse.

	<b><i>Prior installation and start, it is necessary to analyse whether the device complies with the usage requirements regarding particular hazardous area. The analysis must be carried out by a qualified personnel.</i></b>
	<b><i>Installation has to be carried out by an authorized personnel in accordance with regulations, standards and good engineering practice.</i></b>

### 6.1. Power Supply Arrangement

The power supply must be unpacked in safe area.

In the place of operation, the power supply has to be placed on an even and stable ground, away from heat sources and processes in which electrostatic dischargers occur. The power supply has to be protected against solar radiation.

	<b><i>All safety conditions have to be maintained when transporting the power supply to a different workstation.</i></b>
---	--

### 6.2. Connectors Arrangement

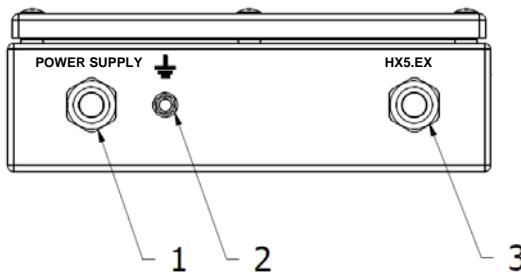



Fig.6. Power supply connectors arrangement PM01.EX-\*

- 1 - Cable gland for power cord.
- 2 - Grounding terminal.
- 3 - Cable gland for receiver power cord.



### 6.3. Power Supply Grounding

- Prepare the functional grounding cable.
- Install the power supply at the workstation.
- Connect the functional grounding cable to the equipotential bonding and to the power supply.
  - The functional grounding cable must be terminated with ring, of 5.2mm diameter, enabling you to couple the cable to the grounding terminal.
  - Use lock washer in order to keep the ring pressed tightly against the housing.
  - Use grounding cable of 4mm<sup>2</sup> cross-section with yellow-green shield.
  - Connect the power supply and the device it powers to the same equipotential bonding.

	<b><i>Spots marked with „<math>\perp</math>” symbol are intended for the functional grounding cable.</i></b>
	<b><i>Connect the power supply and the grounding when there is no risk of explosive atmosphere occurrence.</i></b>

### 6.4. Connecting PUE HX5.EX-\* Indicator to the Power Supply

Connection of the PUE HX5.EX-\* indicator to power supply is carried out by the manufacturer at the stage of production, the connection is of fixed type. If there is a need to disconnect the power supply, e.g. in order to run the cable through walls etc., it is allowed to disconnect the power cord from the receiver.

	<b><i>Disconnect the indicator from the power supply when there is no risk of explosive atmosphere occurrence.</i></b>
	<b><i>Prior 'indicator' - 'power supply' cable disconnection, it is necessary to disconnect the power supply from the mains first.</i></b>
	<b><i>Disconnect the cable from the power supply EXCLUSIVELY.</i></b>

Cable disconnection procedure:

- Remove or cut the security seals on the cover (removing only this seals does not result in loss of the warranty).
- Evenly undo bolts (two turns) fixing the cover.
- Remove the cover and undo gland's cup nut.

- Unplug the cable wires from the intrinsically safe connector.
- Remove the ferrite toroid bead from the cable.
- Remove the cable from the cable gland.

Cable reconnection procedure:

- Lead the cable through the cable gland in the power supply housing.
- Plug the cable wires to the intrinsically safe connector in accordance with the figure presented below.
- Put the ferrite toroid bead onto the cable approximately 3 cm from the cable gland.
- Tighten the gland's cup nut, 5Nm torque.
- Apply the cover and tighten the bolts, 0.5Nm torque.
- Apply security seals.



***Incorrectly closed cover and poorly tightened glands result with loss of IP rating and safety of the complete set.***

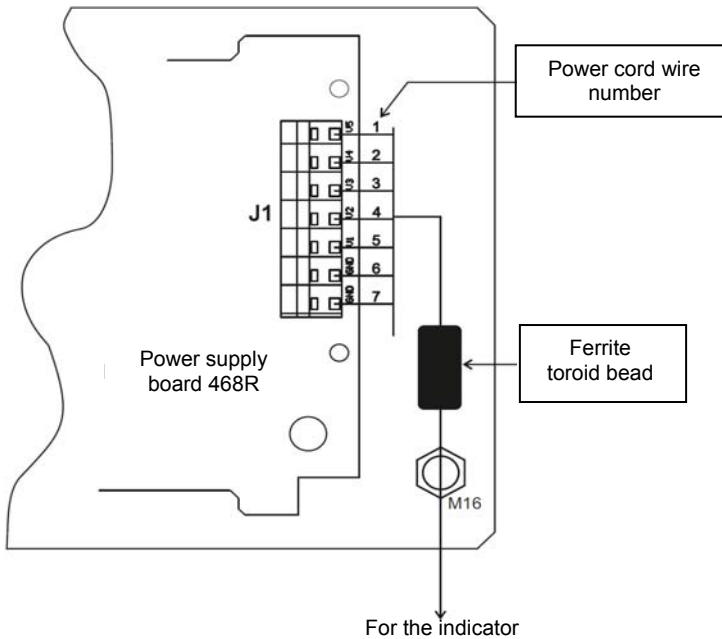

*Fig.7. Connection method of the intrinsically safe cable*

## 6.5. Connecting PM01.EX-\* to the Mains

PM01.EX-\* power supply comes in two installation options:

- **PM01.EX-1** - intended for operation in hazardous area,
- **PM01.EX-2** - intended for operation in safe area.

Depending on the installation option, connection method is different:

- **PM01.EX-1 power supply** – equipped with power cord without the plug. The power cord's wires ends are prepared (stripped, tin-plated or terminated with tubular end sleeves).
  - You can select the connector and connect the device to the mains.
  - The plugs and terminal blocks must meet the standards applicable to the respective hazardous area.
  - Power supply installation has to be carried out by an authorized personnel in accordance with regulations, standards and good engineering practice.

Wires colours in the power cord and their meaning:

Brown or black or grey	phase	L
Blue	neutral	N
Yellow-green	protective	PE



***Connect the PM01.EX-\* power supply to the mains when there is no risk of explosive atmosphere occurrence.***

- **PM01.EX-2 power supply** – equipped with a plug with a ground pin, adapted for mains supply for a given region. Connect the cable to the wall outlet with a ground pin.







***PM01.EX-2 power supply's plug cannot be connected to the wall outlet located in the hazardous area.***



## 7. MAINTENANCE ACTIVITIES

Prior maintenance it is necessary to disconnect the power supply from the mains, and to check grounding connection and state.

You can clean the power supply using regular household cleaners.

	<b><i>Clean the power supply when there is no risk of occurrence of explosive atmosphere.</i></b>
	<b><i>To minimize electrostatic discharge hazard, clean the housing using a wet cloth. It is especially important if the power supply is operated in a room where there is dry air. Moisture protects against accumulation of electrostatic charges.</i></b>
	<b><i>Avoid using abrasive cleaners while cleaning the power supply, do not use concentrated acids, bases, solvents or alcohol.</i></b>
	<b><i>It is not allowed to clean the power supply using compressed air.</i></b>

## 8. TECHNICAL CONDITION INSPECTION

	<b><i>The technical condition of the PM01.EX-* power supply must be tested and inspected by a trained personnel (familiar with this user manual content) at least once every three months.</i></b>
---	--

In the course of inspection check:

- if there is no mechanical damage
- Functional grounding state:
  - cable-housing connection,
  - connection resistance - Max. 100Ω.
- Cable glands - loose wires impermissible:
  - gland-housing torque – 10Nm,
  - gland's cup nut torque – 5Nm.
- Tightening of the power supply cover - check cover bolts torque and tighten the bolts if necessary (0.5Nm).
- Data plates state - they must be complete and readable (not broken/damaged etc.).

## 9. SERVICE AND REPAIR



***In case of any sign of damage, it is necessary to disconnect the device from the mains immediately. The damaged component must be replaced or repaired by RADWAG service immediately.***

In case of any problems with correct operation of the power supply, contact the closest manufacturer's service point.

In case of defects, deliver the faulty product to the manufacturer's service point. If the product cannot be delivered to the manufacturer's service point, call the service and report the defect. Repair scope and method will be set up.



***The user is NOT ALLOWED to carry out any kind of repair of the device himself/herself. Any attempt of power supply design modification, repair etc. by unauthorized persons, will result with loss of validity of manufacturer-issued certificates, declarations and warranty.***

## 10. UTILISATION

PM01.EX-\* power supplies should be recycled, they are not to be treated as a regular household waste. Indicators to be decommissioned must be decommissioned in accordance with valid legal regulations.



## 11. STANDARDS LIST

The device is manufactured in accordance with the following standards:

1. EN 61326-1:2013 *Electrical equipment for measurement, control and laboratory use - EMC requirements - Part 1: General requirements.*
2. EN 61010-1:2010 *Safety requirements for electrical equipment for measurement, control and laboratory use - Part 1: General requirements.*
3. EN 60079-0:2012 + A11:2013 *Explosive atmospheres - Part 0: Equipment - General requirements.*
4. EN 60079-7:2015 *Explosive atmospheres - Part 7: Equipment protection by increased safety "e".*
5. EN 60079-11:2012 *Explosive atmospheres - Part 11: Equipment protection by intrinsic safety "i".*
6. EN 60079-18:2015 *Explosive atmospheres - Part 18: Equipment protection by encapsulation "m".*
7. EN 60079-31:2014 *Explosive atmospheres - Part 31: Equipment dust ignition protection by enclosure "t".*
8. EN 60529:1991 + A2:2013 *Degrees of protection provided by enclosures (IP Code).*



**RADWAG BALANCES AND SCALES**  
ADVANCED WEIGHING TECHNOLOGIES

